



The World's Sixth Sense®

# THERMAL VISION FOR PROFESSIONAL MARINERS





## NIGHTTIME ON THE WATER MADE SAFER— WITH FLIR

Whether you're a commercial pro or first responder, FLIR maritime thermal imaging systems turn night into day, keeping you safe, secure and underway with confidence.

### WHY THERMAL IS BETTER

Thermal imaging cameras detect and display images based on tiny differences in heat, not light. No matter how much light is available—from pitch black to moonlight to severe midday glare—FLIR detectors capture the thermal energy emitted or reflected by everything, even ice. FLIR cameras then convert changes in temperature into crisp infrared video images, allowing you to see at night and navigate in total darkness.

### CONTENTS

- 4 Thermal Imaging Basics
- 6 Commercial and First Responder Applications
- 8 Ocean Scout Handhelds
- 10 LS-Series Tactical Thermal Night Vision
- 12 BHM-Series Bi-Ocular Thermal Handhelds
- 14 MD-Series Fixed-Mount Thermal Imagers
- 16 M100/M200
- 18 M-Series with Gyro-Stabilization
- 20 M400 Multi-Sensor Camera System
- 22 M400XR Multi-Sensor Camera System
- 24 M500 Long Range Multi-Sensor Camera System
- 26 Product Range Comparison Chart
- 28 Image Resolutions
- 32 Specifications



**FROM THE SMALLEST PATROL BOATS TO THE LARGEST OCEAN-GOING VESSELS, FLIR MARITIME OFFERS CUTTING-EDGE SOLUTIONS THAT ARE RUGGED, RELIABLE, AND SIMPLE TO USE.**

[www.flir.com](http://www.flir.com)

Specifications subject to change without prior notice. Images for reference purposes only



## THERMAL IMAGING BASICS

Thermal imaging works night and day, in total darkness or bright sunlight, through smoke, dust, and even light fog to keep your passengers and crew safe from hazards and threats.

See natural and man-made hazards, such as floating debris, rocks, ice, land, bridge abutments, and other vessels.

Thermal night vision helps you find a person in the water faster than any other night vision technology.

FLIR cameras and thermal video are incredibly intuitive and easy to understand. Quite simply, what you see is what you get.

Daylight cameras, image intensified night vision (I<sup>2</sup>), and the human eye all create images from reflected visible light. Traditional night vision scopes and goggles all take in small amounts of visible light and magnify it. However, traditional imagers have the same limitations as the human eye: if there isn't enough light available, they don't work well. Plus, during daylight and twilight hours, they aren't useful either because there is too much light for them to work effectively.

FLIR thermal cameras work both day and night, regardless of light. They're totally immune to the effects of darkness, glare, or even direct sunlight.

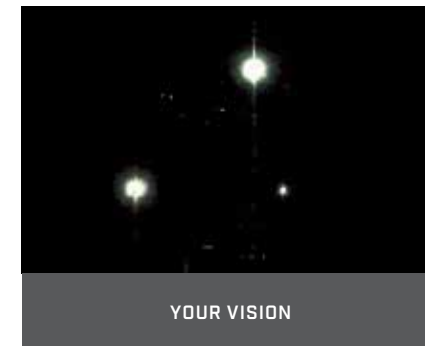

YOUR VISION



TRADITIONAL GEN3 IMAGE INTENSIFIED NIGHT VISION



FLIR THERMAL IMAGE

## RESOLUTION, DETAIL, AND RANGE

FLIR offers a range of thermal imaging cameras with varying levels of image resolution. Much like a digital camera, FLIR cameras with higher pixel counts offer more detail, clarity, and range than models with less resolution. FLIR also offers models with advanced optics for extreme long-range performance.



LOWER RESOLUTION IMAGERS PROVIDE GOOD, BASIC TARGET DETECTION



HIGHER RESOLUTION THERMAL IMAGERS OFFER INCREASED LEVELS OF DETAIL AND LONG-RANGE PERFORMANCE



## FLIR FOR COMMERCIAL MARINERS

### THE SEA CAN BE A DANGEROUS PLACE, ESPECIALLY AT NIGHT

But professional mariners can't call it a day when the weather turns foul. FLIR thermal imagers offer an "early warning system" against common hazards so mariners can sail with confidence, whatever the conditions. FLIR maritime thermal imagers display the invisible heat energy from a myriad of potential hazards, including floating debris, shipping lane traffic, vessels riding at anchor, and small boats. FLIR imagers can also reveal man-made structures, such as buoys, bridge abutments, docks and piers. They can even spot icebergs and surfacing whales.



## FLIR FOR FIRST RESPONDERS

### THERMAL VISION: THE 24/7 TACTICAL ADVANTAGE

First responders gain critical tactical awareness using FLIR thermal cameras, day or night, in good weather and bad. With FLIR thermal vision you can observe suspicious activity in total darkness, quickly locate people in the water, and avoid obstacles while going full throttle in response to emergencies. From border patrols to port security, search and rescue to drug interdiction, FLIR thermal imaging cameras can greatly enhance critical mission success.



MONITOR CREW ON DECK

TRACK POTENTIALLY THREATENING VESSELS

LOCATE ICEBERGS



SEE SUSPECTS IN THE DARK

GAIN SITUATIONAL AWARENESS WHEN APPROACHING VESSELS

OBSERVE LATE NIGHT ACTIVITY ON SHORE

### RECOMMENDED COMMERCIAL SYSTEMS:



MD Series

M100/200

M-Series

M400

M500

### RECOMMENDED FIRST RESPONDER SYSTEMS:



Ocean Scout

LS-Series

BHM-Series

MD Series

M-Series

M400



## OCEAN SCOUT HANDHELD

### PORTABLE THERMAL NIGHT VISION

Ocean Scout is a rugged, compact thermal night vision camera that reveals other vessels, landmarks, buoys, and floating debris day or night. Equipped with a high-resolution LCD display and FLIR's industry-leading sensor technology, Ocean Scout puts enhanced situational awareness in your hand at a moment's notice.



### DETECTION RANGES\*

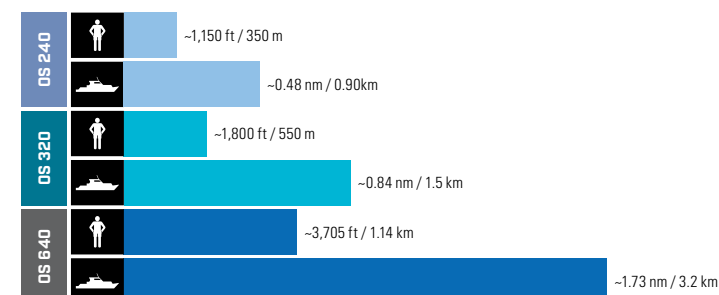

\*Actual range may vary depending on camera set-up, environmental conditions, and user experience.

### ENHANCED AWARENESS

- See marine traffic and navigational aids at night.
- Quickly scan your surroundings for other vessels.
- Easily recognize buoys in river channels or open water.
- Detect key landmarks like islands or docks.

### STEER CLEAR

- Navigate with confidence day or night.
- Avoid obstacles, such as exposed rocks, floating logs, ice, and other debris.
- Be aware of kayakers, personal watercraft, and small boats without lights.
- Detect marine mammals on the surface of the water.

### STAY SAFE

- A lifesaving tool for a "man overboard" emergency.
- Locate the body heat of anyone in the water.
- Quickly recognize people and pets overboard.
- InstAlert™ mode highlights the hottest objects in red.

For technical specifications, turn to page 32



IDENTIFY OTHER VESSELS



FIND PEOPLE OVERBOARD FASTER WITH INSTALERT™



SEARCH FOR EVIDENCE OR PURSUE A SUSPECT IN TOTAL DARKNESS

[www.flir.com](http://www.flir.com)

Specifications subject to change without prior notice. Images for reference purposes only







## LS-SERIES TACTICAL THERMAL NIGHT VISION

### THEY CAN RUN BUT THEY CAN'T HIDE

FLIR's LS-X and LS-XR handheld thermal night vision monoculars are built specifically for those who serve and protect. As a proven force-multiplier, the LS-Series helps maritime first responders see clearly at night while conducting search and rescue missions, patrolling ports and harbors, assisting disabled boaters, and even responding to HAZMAT emergencies. The new LS-X and the LS-XR feature enhanced resolution displays, extended zoom capabilities, a tactical marking laser, and video output.



-  Compact and lightweight
-  Easy-to-use 3-button design
-  IP67 Submersible (to 3.2ft / 1m)
-  White Hot, Black Hot and InstAlert™ detection palettes
-  Use the integrated marking laser to highlight targets of interest not visible to other officers
-  Available in 336 x 256 or 640 x 512 resolutions (30Hz)

### DETECTION RANGES

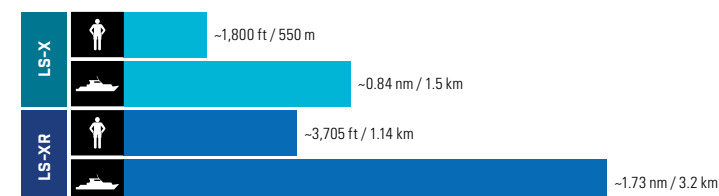

### IMPROVED AWARENESS

- Enhanced high-resolution LCD display
- Video output capability
- Up to 8x magnification

### SIMPLE OPERATION

- Starts up in seconds
- Multiple InstAlert™ levels call attention to hot objects
- Intuitive menu navigation
- Red marking laser for highlighting targets of interest or hidden suspects

### PORTABLE AND RUGGED

- Fits in packs, pockets or included Molle bag
- Rubberized armor protection from accidental drops
- Waterproof, all-weather construction

*For technical specifications, turn to page 32*



MONITOR PORT ACTIVITIES



INVESTIGATE SUSPICIOUS BEHAVIOR



FIND OIL SLICKS AND OTHER TOXIC SPILLS

[www.flir.com](http://www.flir.com)

Specifications subject to change without prior notice. Images for reference purposes only



## BHM-SERIES BI-OCULAR THERMAL HANDHELDS

### SUPERIOR HANDHELD THERMAL VISION

BHM-Series cameras are the most powerful handheld thermal night vision camera for search and rescue operations on the water. With interchangeable 35, 65, and 100 mm lenses, the BHM-Series handhelds can detect a small vessel at a distance of more than five nautical miles (up to 8.8 km). The bi-ocular design lets you use both eyes, and features a full-coverage eyepiece, interocular adjustment, and ergonomic comfort—a must for extended use. The BHM-Series also captures still images and video using an onboard SD card.

### SIMPLE OPERATION

- Intuitive menu options
- Fast power & battery swap
- Multiple InstAlert™ levels call attention to hot objects
- Record stills and NTSC / PAL video to SD card

### LONG RANGE DETECTION

- Up to 640 x 480 thermal resolution
- Interchangeable 35/65/100 mm lenses
- Detect small vessels up to distance of 5.5 miles (8.8 km)

### PORTABLE AND RUGGED

- IP-67, submersible
- Camera body withstands 1 m drop
- Ergonomic comfort

*For technical specifications, turn to page 32*



### DETECTION RANGES

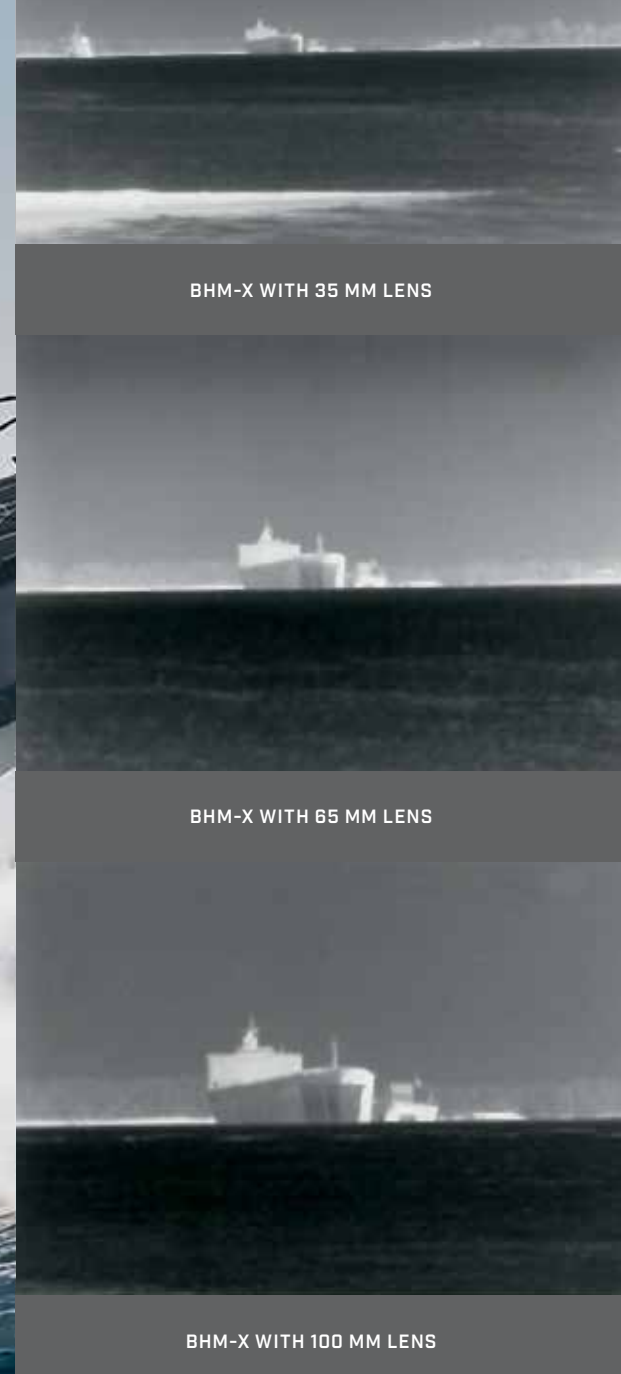
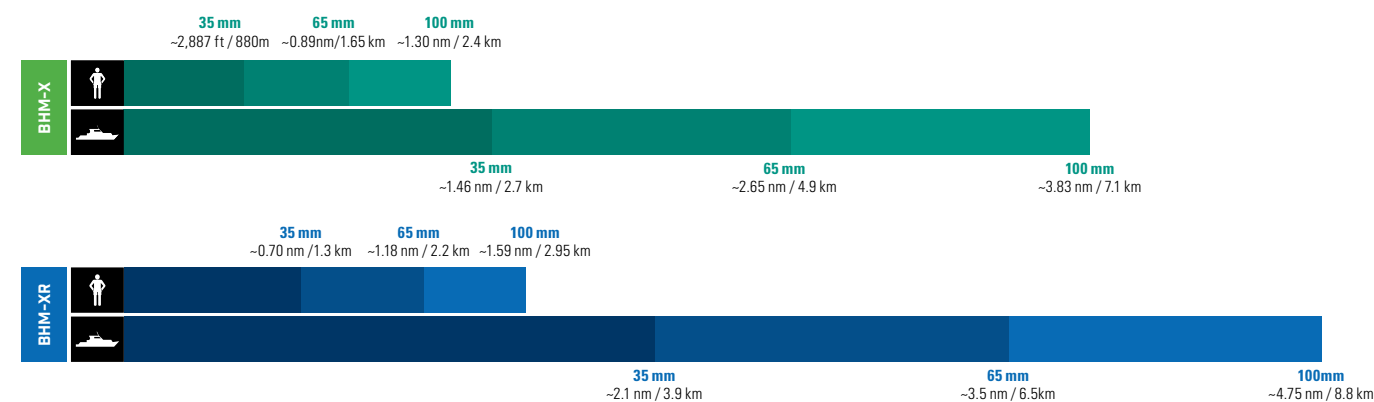







## MD-SERIES FIXED MOUNT THERMAL VISION CAMERAS

### COMPACT, EFFECTIVE AND SIMPLE THERMAL VISION

This affordable, fixed-mount thermal night vision system helps you steer around obstacles, avoid collisions, and find people in the water, day or night. The MD camera body is simple to mount and easy to integrate into existing electronics.



-  320 x 240 or 640 x 480 resolutions produces clear, detailed images
-  2x and 4x e-Zoom for extended range performance
-  Automatic window heaters keep optics free of ice
-  Ethernet-enabled for simple integration into your current electronics
-  Slim profile (7" high and only 1.36 kg/3 lbs) for an unobtrusive mount

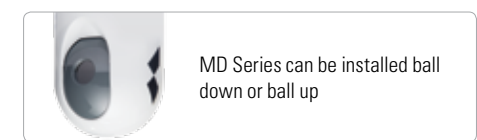

### DETECTION RANGES

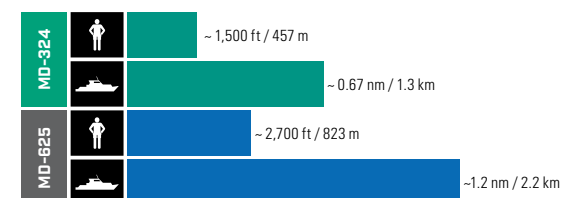

### HIGH RESOLUTION THERMAL VISION

- Available in 320 x 240 / 640 x 480 resolutions
- 2x E-Zoom standard; 4x E-Zoom (MD-625)
- Detects small vessels up to 1.2 nm away

### COMPACT, UNOBTRUSIVE MOUNTING

- Only 7" high and weighs 1.36 kg (3 lbs).
- All-weather, waterproof enclosure
- Ball-up or ball-down mounting options

### INTEGRATES WITH EXISTING ELECTRONICS

- Ethernet-enabled, connects to most popular MFDs
- Optional control using iOS device via onboard Wi-Fi network
- Analog video output for easy connection to onboard monitors, recorders, or DVR systems.

For technical specifications, turn to page 33



EASILY SEE NAVIGATION AIDS MASKED BY BRIGHT URBAN BACKGROUND LIGHTING



SPOT CROSSING TRAFFIC, OBSTACLES AND HAZARDS



DETECT SMALL CRAFT, KAYAKERS AND OTHER UNLIT VESSELS







## M132 AND M232 THERMAL VISION CAMERAS

### NAVIGATING AT NIGHT JUST GOT EASIER

The M100 and M200 Series thermal night vision cameras from FLIR take affordability and easy integration to a whole new level. Packing 320x240 thermal resolution, video over IP, and 4x digital zoom into the smallest, lightest pan/tilt housing on the market, the M100 and M200 are the perfect additions to any vessel. Installation is plug-and-play easy with Raymarine's family of LightHouse powered multifunction displays.

NEW FOR 2017



-  320x240 resolution for clear, detailed images (9Hz)
-  4x e-Zoom for extended range performance
-  Ethernet-enabled for simple integration with your other electronics
-  Tilt only or full pan/tilt options
-  Rugged, waterproof gimbal enclosure with automatic window heaters for ice management.



M100/200 Series can be installed ball down or ball up



Optional compact JCU-3 controller



**ENHANCED AWARENESS WITH FLIR AND RAYMARINE**  
Combine the M132 or M232 with a Raymarine Axiom MFD and take advantage of ClearCruise™ intelligent thermal analytics. ClearCruise™ provides audible and visual alerts when "non-water" objects such as boats, obstacles, or navigation markers are identified in the scene.

### DETECTION RANGES



### THE POWER OF THERMAL VISION

- See bridges, docks, buoys, and debris in the water for improved navigation and safety
- Thermal vision helps you see other vessels, avoid collisions, and verify radar returns
- Helps boaters find people in the water faster than with spotlights and radar alone

### MORE THERMAL CAPABILITY FOR LESS

- Full 320x240 resolution for optimal image detail
- The M200 is equipped with a pan/tilt housing for horizon-to-horizon viewing
- 2X digital zoom for longer range performance

### EASY INSTALLATION ON ANY VESSEL

- IP video for easier integration on multiple MFDs
- Smaller size and lighter weight make mounting easy
- M100's tilt option lets you position the camera for optimum visibility, whether you're running fast or slow

For technical specifications, turn to page 33



AVAILABLE CLEARCRUISE IR ANALYTICS ALERT YOU TO HAZARDS AND OBSTACLES ON THE WATER™



GENUINE FLIR THERMAL TECHNOLOGY FOR CRISP, CLEAR IMAGERY



4X CONTINUOUS DIGITAL ZOOM FOR ENHANCED VIEWING OF DISTANT OBJECTS

www.flir.com

Specifications subject to change without prior notice. Images for reference purposes only









## M-SERIES NEXT GENERATION MARINE THERMAL VISION CAMERAS

### HIGH PERFORMANCE THERMAL VISION- NOW EVEN BETTER

The next generation M-Series takes everything that has made M-Series the most popular line of marine thermal night vision cameras in the world and makes it even better. Updated with improved thermal imaging cores and optics for next-level performance, a better daylight/lowlight camera option, and gyro-stabilization as a standard feature across the entire line, M-Series has made the best even better.

NEW FOR 2017



-  Active gyro-stabilization automatically keeps the image steady in rough seas
-  High resolution color camera system with 36x Optical Zoom and low-light mode
-  Automatic window heaters keep optics free of ice
-  2x and 4x E-Zoom functions
-  Ethernet control link for easy networking to FLIR joysticks or multifunction displays
-  Standard analog video signal displays on any monitor with an auxiliary video input
-  Rugged, waterproof gimbal enclosure with automatic window heaters for ice management.

M-Series thermal cameras can be installed ball down or ball up



Joystick controller included



Compatible with multifunction navigation displays from Raymarine, Garmin, Furuno and Simrad or display on any onboard screen or monitor with an analog video input.

### DETECTION RANGES

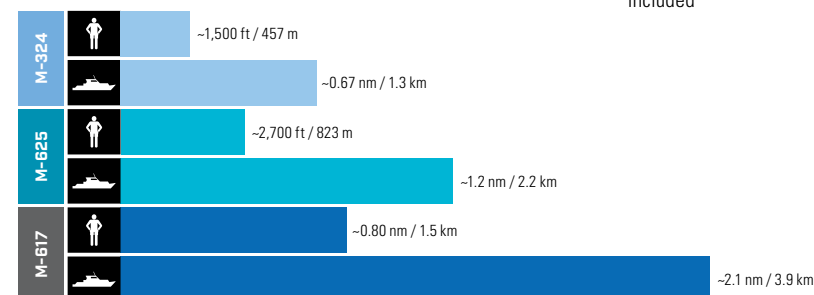

### ENHANCED AWARENESS IN ALL CONDITIONS

- Improved rough weather performance using active gyro stabilization
- Dual Payload models combine a thermal camera with 36x zoom low-light color camera for enhanced awareness in all conditions
- Latest generation FLIR thermal core technology detects other hazards—day or night—through darkness, glare, dust and light fog

### EASY TO INTEGRATE

- Integrates seamlessly with existing electronics including select multifunction displays from Raymarine®, Furuno, Garmin, and Simrad
- Slew-to-Cue and ARPA radar target tracking from compatible radar, AIS and chart systems
- Simple joystick control of pan, tilt and zoom and composite video output for easy connection to MFDs and monitors

### WEATHERPROOF, CONTROLLABLE PAN & TILT SYSTEM

- Engineered especially for harsh marine environments
- Color symbology on-screen gives instant access to system status, position, and configuration
- 360° Continuous Pan, +/-90° Tilt with joystick control

For technical specifications, turn to page 34



SEE RIVER TRAFFIC WITHOUT BEING BLINDED BY SUN GLARE



MANEUVER BETWEEN DOCKS AT NIGHT



REMAIN AWARE OF CHANNEL LANDMARKS

www.flir.com

Specifications subject to change without prior notice. Images for reference purposes only



# M400 MULTI-SENSOR CAMERA SYSTEM

## ADVANCED LONG RANGE THERMAL VISION

The M400's advanced 640 x 480 sensor delivers crisp thermal video images in total darkness and lowlight conditions. An integrated HD Color visible camera and tight-beam LED spotlight augments target identification for added safety. M400 has a continuous optical thermal zoom lens (up to 4x) that allows operators to see other vessels and targets at longer ranges. Active gyro-stabilization ensures a steady image, plus radar tracking keeps potentially dangerous targets in view at all times.



-  High intensity LED spot-beam can highlight targets of interest, while preserving the night vision of on-deck personnel
-  HD Color low-light camera with 30x optical zoom
-  Gyro stabilized to ensure steady viewing in heavy sea conditions
-  High resolution 640 x 480 thermal sensor, optical zoom 18° to 6° horizontal field of view (9 or 30Hz)
-  Rugged, waterproof gimbal enclosure with automatic window heaters for ice management.
-  360° pan and +/-90° tilt capability



M400 Series thermal cameras can be installed ball down or ball up



### JOYSTICK CONTROL

The joystick is the primary control for the M400. It is used to wake the system or put it in standby, operate the pan and tilt movement, zoom the camera, control cameras modes and features, and configure system settings by means of OSD menus.

## DETECTION RANGES

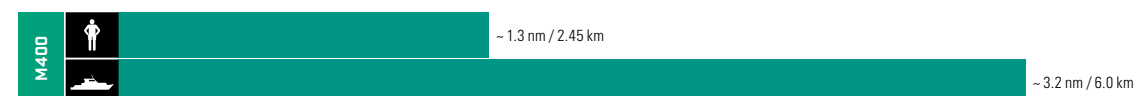

### ICEALERT™ MODE

In IceAlert™ mode the coldest temperatures in the image are highlighted in Blue-Green shades, while warmer temperatures are all in shades of gray. Especially useful for locating ice in the dark.

### SHORT AND LONG-RANGE DETECTION

- Recognize marine traffic and key landmarks at night
- Continuous variable zoom allows you to easily identify vessels or navigation aids in the distance
- Quickly recognize nearby buoys in channels or open water
- Detect key landmarks, such as islands or docks

### THERMAL AND VISIBLE-LIGHT PAYLOADS

- Combination thermal detection and visible identification
- Up to 3x optical thermal zoom for 18° to 6° HFOV
- HD Color 30x Zoom provides 64° to 2.3° HFOV
- Illuminate and identify nearby targets with powerful LED beam

### ENHANCED TARGET IDENTIFICATION

- InstAlert™ mode depicts the hottest object in shades of red and orange for easy identification
- IceAlert™ – helps identify floating ice by depicting the coolest objects in shades of blue and green
- Radar integration lets the M400 follow specific radar targets

For technical specifications, turn to page 35



6° TO 18° THERMAL HORIZONTAL FIELD OF VIEW



A TIGHT BEAM LED SPOTLIGHT AUGMENTS TARGET IDENTIFICATION



CONTINUOUS OPTICAL ZOOM AND GYRO-STABILIZATION FOR SUPERIOR LONG-RANGE PERFORMANCE





# M400XR MULTI-SENSOR CAMERA SYSTEM

## ADVANCED THERMAL VISION FOR FIRST RESPONDERS

The M400XR incorporates all the features of the M400 but adds integrated video tracking – lock on and automatically follow objects as long as they're in view of camera – and a firefighting mode.



-  IP Video, HD-SDI, and Analog video outputs. Raymarine MFD integration
-  Video tracking: follow objects in the camera's view
-  Firefighting mode optimizes the color palette to see hot spots and take temperature measurements on scene



### JOYSTICK CONTROL

The joystick is the primary control for the M400. It is used to wake the system or put it in standby, operate the pan and tilt movement, zoom the camera, control cameras modes and features, and configure system settings by means of OSD menus.

### ENHANCED USER INTERFACE

The M400's enhanced user interface simplifies camera operation and configuration.



Typical screen showing on-screen menu bar

### ENHANCED VISUAL NAVIGATION

The M400's thermal and visual cameras with optical zoom provide exceptional long range performance, giving captains the ability to visually confirm distant targets with greater clarity.



### DETECTION RANGES

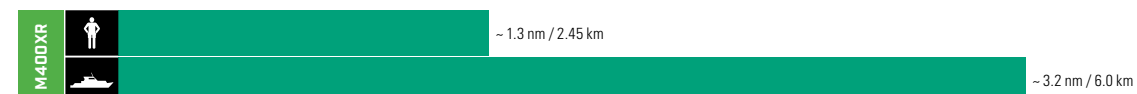

### FIREFIGHTING MODE

The M400XR's firefighting mode provides enhanced awareness with a target temperature meter and isotherm displays.



### VIDEO TARGET TRACKING

The M400XR's intelligent video tracking automatically changes the camera's view to track a moving vessel or stay locked on a stationary target. This feature allows captains to keep the camera locked on to an emergency scene or a potential suspect

*For technical specifications, turn to page 35*



SMALL CRUISE SHIP AT DUSK VIEWED WITH THE LOW-LIGHT VIDEO CAMERA. TRACKING MODE ENGAGED TO FOLLOW THE SHIP



STABILIZED VIDEO OF VESSEL IN THE HARBOR USING ZOOM

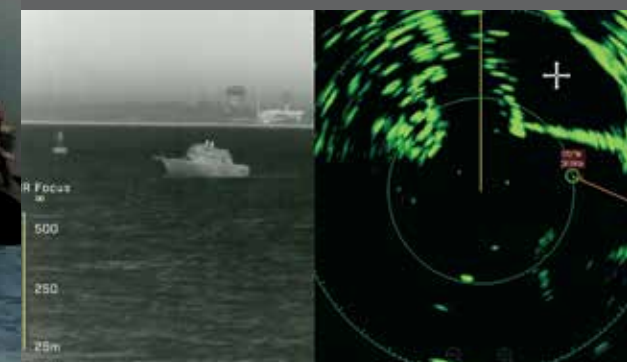

THE M400XR CAN TRACK AND KEEP ARPA RADAR TARGETS IN VIEW WITH COMPATIBLE MFDS AND RADAR SYSTEMS











# M500 ULTRA HIGH PERFORMANCE MULTI-SENSOR CAMERA SYSTEM

## PREMIUM LONG RANGE THERMAL VISION

The FLIR M500 cooled thermal night vision camera is our most technologically advanced M-Series camera ever. Designed around a cryogenically cooled Mid Wave Infrared (MWIR) thermal sensor, it excels at both short and ultra-long range target detection and identification. The M500 includes a cooled midwave, high resolution 640 x 512 pixel thermal camera with a 1X to 14X continuous optical zoom and a field of view between 28° and 2°. It also comes with an integrated HD color visible camera system and a spot-beam LED target illumination system. Built on a ruggedized marine gimbal system, the M500 is a pan and tilt camera with standard gyro stabilization, video tracking and radar integration.

NEW FOR 2017



-  High intensity LED spot-beam can highlight targets of interest, while preserving the night vision of on-deck personnel
-  HD Color lowlight camera with 30x optical zoom
-  Gyro stabilized to ensure steady viewing in heavy sea conditions
-  Cooled MWIR Thermal imager with 640 x 512 resolution and 14xOptical Zoom
-  Rugged, waterproof gimbal enclosure with automatic window heaters for ice management.
-  360° pan and +/-90° tilt capability
-  Video tracking: follow objects in the camera's view
-  Firefighting mode optimizes the color palette to see hot spots and take temperature measurements on scene

## SUPERIOR SHORT- AND LONG-RANGE VISION

- Cooled thermal core technology and continuous optical zoom enables early detection of vessels or navigation aids in the distance
- Active gyro stabilization delivers a steady image in rough seas, simplifying target identification and enhancing situational awareness
- Superior FLIR thermal technology allows captain to quickly recognize nearby buoys and detect key landmarks, such as islands or docks

## ENHANCED TARGET AWARENESS

- Video target tracking automatically keeps the M500 locked onto a moving or stationary target
- Radar integration allows the M500 to automatically track selected radar targets
- Firefighting mode provides enhanced awareness for first responders with a target temperature meter and isotherm displays

## ENHANCED CLARITY:

- High performance thermal and visible camera payloads for detection and visible identification
- A 14x optical thermal zoom and a field of view between 2° and 28° enables long range target detection
- Easily identify long range targets with a HD color visible camera with 30x zoom and 64° to 2.3° HFOV
- The M500's integrated spotlight illuminates nearby targets with powerful LED beam

For technical specifications, turn to page 35



THE COOLED THERMAL CORE OF THE M500 PROVIDES HIGH CONTRAST THERMAL IMAGES.



NEGOTIATE TIGHT WATERWAYS IN TOTAL DARKNESS WITH CONFIDENCE.



IDENTIFY LONG RANGE TARGET BOTH DAY AND NIGHT WITH THE M500 HIGH PERFORMANCE VISIBLE ZOOM CAMERA.

## DETECTION RANGES



www.flir.com

Specifications subject to change without prior notice. Images for reference purposes only



## RANGE COMPARISON CHART

The following chart compares the man-overboard and small vessel detection distances for the FLIR range of thermal cameras.

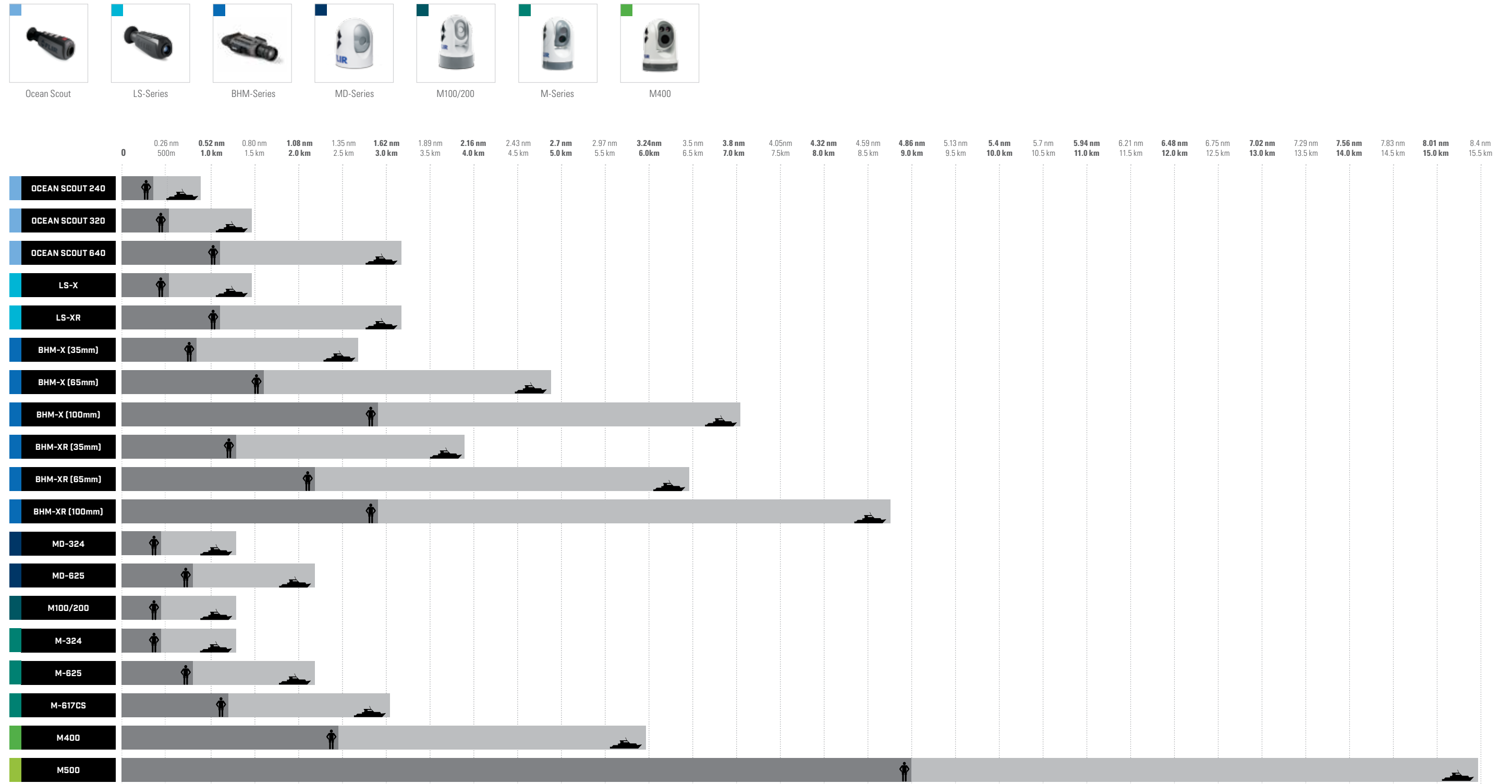

Specifications subject to change without prior notice. Images for reference purposes only.

Specifications subject to change without prior notice. Images for reference purposes only.



## IMAGE RESOLUTION AND SAMPLE IMAGES

### OCEAN SCOUT – HANDHELD

The FLIR Ocean Scout puts advanced thermal imaging in the palm of your hand. With thermal vision, you can peer into darkness and see objects and your surroundings as clear as day, keeping you safer, and making your time on the water more relaxing. Resolutions range from 280 x 180 to 640 x 512 pixels, depending upon the model.



OS-240	OS-320	OS-640
240 x 180 pxl	336 x 256 pxl	640 x 512 pxl



### BHM-SERIES – HANDHELD

With powerful interchangeable lenses, BHM-Series cameras are the most powerful handheld, battery-powered, thermal night vision cameras available, making them the right choice for use on vessels of any size, and giving you the edge in all of your nighttime travels. There are two models to choose from: BHM-X (320 x 240 pixels) and the BHM-XR (640 x 480 pixels).



BHM-X SERIES	BHM-XR SERIES
320 x 240 pxl	640 x 512 pxl



### LS SERIES – HANDHELD

This powerful, yet simple imager gives Law Enforcement an unfair advantage whether searching for evidence or pursuing a suspect, all in the palm of your hand. The newest additions to this field-proven line, LS-X and the LS-XR, feature enhanced resolution displays, extended zoom capabilities, and video output.



LS-X SERIES	LS-XR SERIES
336 x 256 pxl	640 x 512 pxl



### MD-SERIES – COMPACT THERMAL NIGHT VISION CAMERAS

These fixed-mount thermal night vision cameras help with steering around obstacles, collision avoidance and finding people in the water at night. There are two models to choose from: MD-324 (320 x 240 pixels) and the MD-625 (640 x 480 pixels).



MD-324	MD-625
320 x 240 pxl	640 x 480 pxl

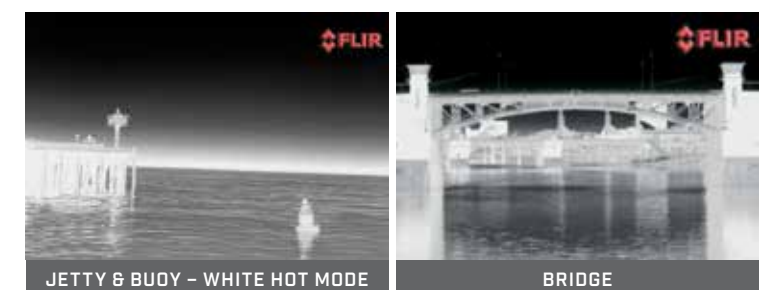



## IMAGE RESOLUTION AND SAMPLE IMAGES

### M100/M200 SERIES MARINE THERMAL VISION CAMERAS

Get the clear vision you need to navigate around obstacles, avoid collisions, and find people in the water at night. M232 provides full pan/tilt for horizon-to-horizon vision, while the M132 allows for tilt position to compensate for changes in deck angle.



M132	M232
320 x 240 pxl	320 x 240 pxl



### M-SERIES: NEXT GENERATION MULTI-SENSOR THERMAL NIGHT VISION

The M-Series creates thermal images with tremendous detail for such an affordable night vision system. You will see more—and see farther—even in the dead of night. An optional lowlight TV camera provides enhanced navigational abilities during twilight hours. And M-Series cameras also feature detailed, color on-screen symbology for instant access to system status, position, and configuration. Resolution (320 x 240 or 640 x 480 pixels) is model dependent.



M-324	M-625
320 x 240 pxl	640 x 480 pxl



Images for illustrative purposes only

### M400 & M400XR: ADVANCED MULTI-SENSOR THERMAL NIGHT VISION

The FLIR M400's advanced 640x480 sensor delivers crisp thermal video images in total darkness and low-light conditions. An integrated HD color visible camera and narrow-beam LED spotlight augment target identification for added safety.



M400	M400-XR
640 x 480 pxl	640 x 480 pxl



### M500: HIGH-PERFORMANCE MARINE MULTI-SENSOR CAMERA SYSTEM

The FLIR M500's advanced 640x512 sensor delivers crisp thermal video images in total darkness and low-light conditions. An integrated HD color visible camera augments target identification for added safety.



M500
640 x 512 pxl



Images for illustrative purposes only



**OCEAN SCOUT SPECIFICATIONS**

	OCEAN SCOUT 240	OCEAN SCOUT 320	OCEAN SCOUT 640
			
<b>GENERAL</b>			
Detector Resolution	240 x 180	336 x 256	640 x 512
Refresh Rate	9 Hz		
Field of View	24° x 18°	17° x 13°	18° x 14°
Zoom	NA	2x E-Zoom	2x, 4x, and E-Zoom
Color Palettes	White Hot / Black Hot / InstAlert™		
Battery	Internal Lithium Ion rechargeable (5-hour typical life)		
Waterproofing	IP-67 Submersible to 1 Meter		
Weight	0.75lb (0.34 kg)		
<b>RANGE PERFORMANCE</b>			
Man	1,150 ft (350 m)	1,800 ft (550 m)	3,705ft (1.14 km)
Vehicle/vessel	0.48 nm (0.90 km)	0.84 nm (1.5 km)	1.73 nm (3.2 km)

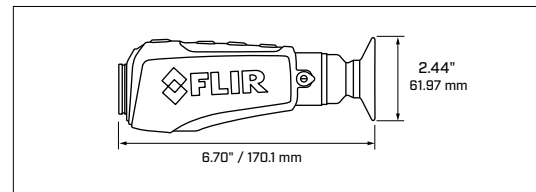

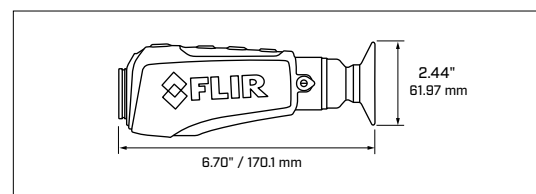

**LS-SERIES SPECIFICATIONS**

	LS-X	LS-XR
		
<b>GENERAL</b>		
Detector Resolution	336 x 256	640 x 512
Refresh Rate	9 Hz or 30 Hz	
Field of View	17° x 13°	18° x 14°
Zoom	2x and 4x E-Zoom	2x, 4x, and 8x E-Zoom
Color Palettes	White Hot / Black Hot / InstAlert™	
Battery	Internal Lithium Ion rechargeable, (5-hour typical life)	
Laser Pointer	Red Laser Pointer	
Video Output	NTSC or PAL composite via supplied cable	
Waterproofing	IP-67 Submersible to 1 meter	
Weight	0.75lb (0.34 kg)	
<b>RANGE PERFORMANCE</b>		
Person in the Water (6 x 1.6 ft / 1.8 x 0.5 m)	1,870 ft (570 m)	0.62 nm (1.14 km)
Small Vessel (13 x 5.0 ft / 4.0 x 1.5 m)	0.84 nm (1.55 km)	1.62 nm (3 km)



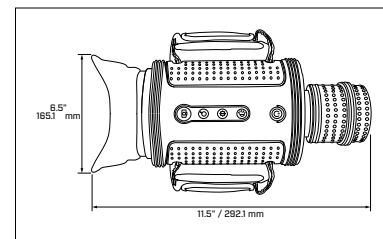

**BHM-SERIES SPECIFICATIONS**

	BHM-X+	BHM-XR+
		
<b>GENERAL</b>		
Detector Resolution	320 x 240	640 x 480
Refresh Rate	9 Hz or 30 Hz	
Field of View:		
35 mm lens	13° x 10°	18° x 13°
65 mm lens	7° x 5°	10° x 8°
100 mm lens	5° x 3°	6° x 4°
Zoom	2x E-Zoom	2x and 4x E-Zoom
Color Palettes	White Hot / Black Hot / InstAlert™; Selectable	
Battery	4 AA Batteries, NiMH Li-Ion or Alkaline	
Video Output	NTSC or PAL composite via supplied cable	
Waterproofing	IP-67 Submersible to 1 Meter	
Weight:		
with 35 mm lens	0.84 lbs (0.38 kg)	
with 65 mm lens	3.05 lbs (1.38 kg)	
with 100 mm lens	3.06 lbs (1.39 kg)	
<b>RANGE PERFORMANCE</b>		
Person in the Water (6 x 1.6 ft / 1.8 x 0.5 m):		
35 mm lens	2,887 ft (880 m)	0.70 nm (1.3 km)
65 mm lens	0.89 nm (1.65 km)	1.18 nm (2.2 km)
100 mm lens	1.30 nm (2.4 km)	1.59 nm (2.95 km)
Small Vessel (13 x 5.0 ft / 4.0 x 1.5 m):		
35 mm lens	1.46 nm (2.7 km)	2.1 nm (3.9 km)
65 mm lens	2.65 nm (4.9 km)	3.5 nm (6.5 km)
100 mm lens	3.83 nm (7.1 km)	4.75 nm (8.8 km)



**MD-SERIES SPECIFICATIONS**

	MD-324	MD-625
		
<b>MAIN THERMAL CAMERA</b>		
Detector Type	320 x 240 VOx Microbolometer	640 x 480 VOx Microbolometer
Video Refresh Rate	<9 Hz or 30 Hz (NTSC and PAL)	<9 Hz or 30 Hz (NTSC and PAL)
Field of View	24° x 18° (NTSC)	25° x 20° (NTSC)
Focal Length	19 mm	25 mm
Focus	Fixed 12ft (3.6m) to infinity	Fixed 12ft (3.6m) to infinity
Optical Zoom	N/A	N/A
E-Zoom	2x	2x, 4x
Image Processing	FLIR Proprietary Digital Detail Enhancement	FLIR Proprietary Digital Detail Enhancement
<b>SYSTEM SPECIFICATIONS</b>		
Video Tracking	No	No
Firefighter Mode	No	No
Pan/Tilt Adjustment Range	Pan: ±30° per key, Tilt: +34°, -27° (Locked in at Installation)	Pan: ±30° per key, Tilt: +34°, -27° (Locked in at Installation)
Analog Video Output	NTSC or PAL, 30 Hz or <9 Hz	NTSC or PAL, 30 Hz or <9 Hz
Analog Video Connector Types	F-type BNC with BNC-to-RCA adapter included for video out	F-type BNC with BNC-to-RCA adapter included for video out
Network Video Output	No	No
HD-SDI Lossless Video Output	No	No
Power Requirements	12-24 V DC via included PoE injector	12-24 V DC via included PoE injector
Power Consumption	4.8 W nominal; 12.5 W max	4.8 W nominal; 12.5 W max
<b>ENVIRONMENTAL</b>		
Operating Temperature Range	-13°F to +131°F (-25°C to +55°C)	-13°F to +131°F (-25°C to +55°C)
Storage Temperature Range	-40°F to +185°F (-40°C to +85°C)	-40°F to +185°F (-40°C to +85°C)
Automatic Window Defrost	Standard at Power-Up	Standard at Power-Up
Sand/Dust Ingress	Mil-Std-810E	Mil-Std-810E
Water Ingress	IPX 6 (heavy seas, powerful jets of water)	IPX 6 (heavy seas, powerful jets of water)
Shock	15 g vertical, 9 g horizontal	15 g vertical, 9 g horizontal
Vibration	IEC 60945; MIL-STD-810E	IEC 60945; MIL-STD-810E
Lightning Protection	Standard	Standard
Salt Mist	IEC60945	IEC60945
Wind	100 knot (115.2 mph)	100 knot (115.2 mph)
EMI	IEC 60945	IEC 60945
<b>PHYSICAL</b>		
Weight	~ 3 lbs (1.36 kg)	~ 3 lbs (1.36 kg)
Size	6" (152.4 mm) dia. x 7" (177.8 mm) ht.	6" (152.4 mm) dia. x 7" (177.8 mm) ht.
<b>RANGE PERFORMANCE</b>		
Person in the Water	1,500 ft (457 m)	2,700 ft (823 m)
Small Vessel	4,200 ft (1280 m)	1.2 nm (2.2 km)

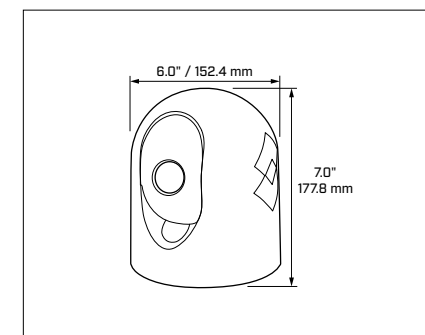

**M100/200 SPECIFICATIONS**

	M100/M200
	
<b>GENERAL</b>	
Detector Type	320 x 240 VOx Microbolometer
Video Refresh Rate	9 Hz
Field of View	24° x 18°
Focal Length	19 mm
E-Zoom	4x
Image Processing	FLIR Proprietary Digital Detail Enhancement
<b>SYSTEM SPECIFICATIONS</b>	
Pan/Tilt Range	M100 – Tilt: +110°, -90° M200 – Pan: 360° (continuous), Tilt: +110°, -90°
Video Output	H264 IP Video stream
Power Requirements	12 or 24 VDC
Power Consumption	15 W (typical) 18 W (max)
<b>ENVIRONMENTAL</b>	
Operating Temperature Range	-13°F to +131°F (-25°C to +55°C)
Storage Temperature Range	-30°F to +158°F (-30°C to +70°C)
Relative Humidity	95% max
Automatic Window Defrost	Standard at Power-Up
Water Ingress	IPX 6 (heavy seas, powerful jets of water)
Shock	15 g vertical, 9 g horizontal
Vibration	IEC 60945; MIL-STD-810E
Salt Mist	IEC 60945
Wind	100 mph (161 kph)
EMI	IEC 60945
<b>PHYSICAL</b>	
Weight	6.0 lb (2.7 kg) w/o top-down riser 6.6 lb (3.0 kg) w/ top-down riser
Size	6.34" (dia. @ base) x 9.03" (ht.) 161.1 (dia.) x 229.3 (ht.) mm
<b>RANGE PERFORMANCE</b>	
Person in the Water	~1,500 ft (457 m)
Small Vessel	~0.67 nm (1.3 km)

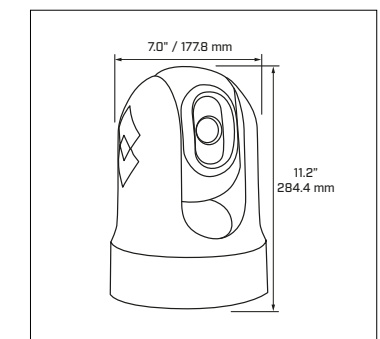



**M-SERIES NEXT GENERATION SPECIFICATIONS**

	M-324S	M-324CS	M-625S	M-625CS	M-617CS
					
<b>MAIN THERMAL CAMERA</b>					
Detector Type	336 x 256 VOx Microbolometer	336 x 256 VOx Microbolometer	640 x 512 VOx Microbolometer	640 x 512 VOx Microbolometer	640 x 512 VOx Microbolometer
Video Refresh Rate	< 9 Hz or 30 Hz (NTSC)	< 9 Hz or 30 Hz (NTSC)	< 9 Hz or 30 Hz (NTSC)	< 9 Hz or 30 Hz (NTSC)	< 9 Hz or 30 Hz (NTSC)
Field of View	24° x 18°	24° x 18°	25° x 20°	25° x 20°	17° x 14°
Focal Length	13 mm	13 mm	25 mm	25 mm	35 mm
Focus	Fixed 14 ft (4.4 m) to infinity	Fixed 14 ft (4.4 m) to infinity	Fixed 69 ft (21 m) to infinity	Fixed 69 ft (21 m) to infinity	Fixed 69 ft (21 m) to infinity
Continuous E-Zoom	4x	4x	4x	4x	4x
Image Processing	FLIR Proprietary Digital Detail Enhancement		FLIR Proprietary Digital Detail Enhancement		
<b>MAIN VISIBLE CAMERA</b>					
Detector Type	N/A	1/2" Interline Transfer Lowlight CCD	N/A	1/2" Interline Transfer Lowlight CCD	1/2" Interline Transfer Lowlight CCD
Lines of Resolution	N/A	530	N/A	530	530
Minimum Illumination	N/A	1.4 Lux	N/A	1.4 Lux	1.4 Lux
Optical Zoom	N/A	36x	N/A	36x	36x
E-Zoom	N/A	12x	N/A	12x	12x
<b>SYSTEM SPECIFICATIONS</b>					
Video Tracking	No	No	No	No	No
Firefighter Mode	No	No	No	No	No
Pan/Tilt Adjustment Range	360° Continuous Pan, +/-90° Tilt	360° Continuous Pan, +/-90° Tilt	360° Continuous Pan, +/-90° Tilt	360° Continuous Pan, +/-90° Tilt	360° Continuous Pan, +/-90° Tilt
Analog Video Output	NTSC, 30Hz or <9Hz	NTSC, 30Hz or <9Hz	NTSC, 30 Hz or <9 Hz	NTSC, 30 Hz or <9 Hz	NTSC, 30 Hz or <9 Hz
Analog Video Connector Types	F-type BNC with BNC-to-RCA adapter included for video out		F-type BNC with BNC-to-RCA adapter included for video out		
Network Video Output	No	No	No	No	No
HD-SDI Lossless Video Output	No	No	No	No	No
Power Requirements	12-24 V DC	12-24 V DC	12-24 V DC	12-24 V DC	12-24 V DC
Power Consumption	25 W nominal; 50 W max	25 W nominal; 50 W max	25 W nominal; 50 W max	25 W nominal; 50 W max	25 W nominal; 50 W max
<b>ENVIRONMENTAL</b>					
Operating Temperature Range	-13°F to +131°F (-25°C to +55°C)	-13°F to +131°F (-25°C to +55°C)	-13°F to +131°F (-25°C to +55°C)	-13°F to +131°F (-25°C to +55°C)	-13°F to +131°F (-25°C to +55°C)
Storage Temperature Range	-40°F to +185°F (-40°C to +85°C)	-40°F to +185°F (-40°C to +85°C)	-40°F to +185°F (-40°C to +85°C)	-40°F to +185°F (-40°C to +85°C)	-40°F to +185°F (-40°C to +85°C)
Automatic Window Defrost	Standard at Power-Up	Standard at Power-Up	Standard at Power-Up	Standard at Power-Up	Standard at Power-Up
Sand/Dust Ingress	Mil-Std-810E	Mil-Std-810E	Mil-Std-810E	Mil-Std-810E	Mil-Std-810E
Water Ingress	IPX 6 (heavy seas, powerful jets of water)		IPX 6 (heavy seas, powerful jets of water)		
Shock	15 g vertical, 9 g horizontal	15 g vertical, 9 g horizontal	15 g vertical, 9 g horizontal	15 g vertical, 9 g horizontal	15 g vertical, 9 g horizontal
Vibration	IEC 60945; MIL-STD-810E	IEC 60945; MIL-STD-810E	IEC 60945; MIL-STD-810E	IEC 60945; MIL-STD-810E	IEC 60945; MIL-STD-810E
Lightning Protection	Standard	Standard	Standard	Standard	Standard
Salt Mist	IEC60945	IEC60945	IEC60945	IEC60945	IEC60945
Wind	100 knot (115.2 mph)	100 knot (115.2 mph)	100 knot (115.2 mph)	100 knot (115.2 mph)	100 knot (115.2 mph)
EMI	IEC 60945	IEC 60945	IEC 60945	IEC 60945	IEC 60945
<b>PHYSICAL</b>					
Weight	~ 9 lbs (4 kg)	~ 9 lbs (4 kg)	~ 9 lbs (4 kg)	~ 9 lbs (4 kg)	~ 9 lbs (4 kg)
Size	7" (177.8 mm) dia. x 11.2" (284.4 mm) ht.	7" (177.8 mm) dia. x 11.2" (284.4 mm) ht.	7" (177.8 mm) dia. x 11.2" (284.4 mm) ht.	7" (177.8 mm) dia. x 11.2" (284.4 mm) ht.	7" (177.8 mm) dia. x 11.2" (284.4 mm) ht.
<b>RANGE PERFORMANCE</b>					
Person in the Water	1,500 ft (457 m)	1,500 ft (457 m)	2,700 ft (823 m)	2,700 ft (823 m)	4,900 ft (1,494 m)
Small Vessel	4,200 ft (1,280 m)	4,200 ft (1,280 m)	1.2 nm (2.2 km)	1.2 nm (2.2 km)	2.1 nm (3.9 km)

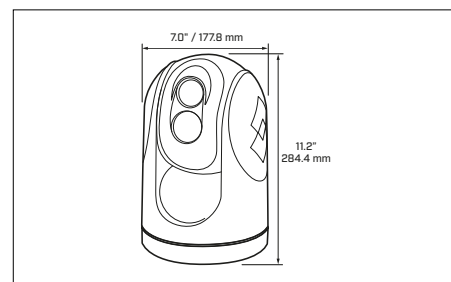

Specifications subject to change without prior notice. Images for reference purposes only.

**M400 SPECIFICATIONS**

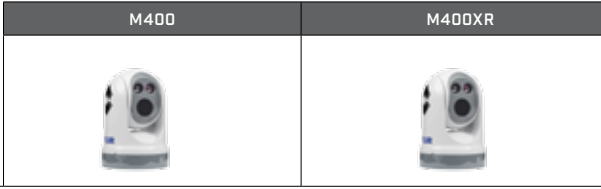
	M400	M400XR
		
<b>MAIN THERMAL CAMERA</b>		
Detector Type	640 x 480 VOx Microbolometer	640 x 480 VOx Microbolometer
Video Refresh Rate	<9 Hz or 30 Hz (NTSC and PAL)	<9 Hz or 30 Hz (NTSC and PAL)
Field of View	18° to 6° HFOV / 1.5° HFOV with E-Zoom	18° to 6° HFOV / 1.5° HFOV with E-Zoom
Focal Length	35 mm (Wide) to 105 mm (Narrow)	35 mm (Wide) to 105 mm (Narrow)
Optical Zoom	1x to 4x	1x to 4x
E-Zoom	1x to 4x	1x to 4x
Image Processing	FLIR Proprietary Digital Detail Enhancement	FLIR Proprietary Digital Detail Enhancement
<b>MAIN VISIBLE CAMERA</b>		
Detector Type	Long-range color daylight and low-light viewing	Long-range color daylight and low-light viewing
Lines of Resolution	High Definition up to 1080/30p	High Definition up to 1080/30p
Minimum Illumination	>0.5 lux at 50 IRE / .05 lux in ICR Mode (B/W)	>0.5 lux at 50 IRE / .05 Lux in ICR Mode (B/W)
Zoom	30x Optical Zoom	30x Optical Zoom
Focal Length	129 mm to 4.3 mm	129 mm to 4.3 mm
Field of View	64° to 2.3° Optical HFOV / 0.2 NFOV E-Zoom	64° to 2.3° Optical HFOV / 0.2 NFOV E-Zoom
<b>SPOTLIGHT SPECIFICATIONS</b>		
Type, Lumens, Beam°	LED, 580 Lumens, 5° Divergence Angle	LED, 580 Lumens, 5° Divergence Angle
<b>SYSTEM SPECIFICATIONS</b>		
Video Tracking	No	Yes
Radar Target Tracking	Yes	Yes
Firefighter Mode	No	Yes
Pan/Tilt Adjustment Range	360° Continuous Pan, +/-90° Tilt	360° Continuous Pan, +/-90° Tilt
Analog Video Output	NTSC or PAL, 30 Hz or <9 Hz	NTSC or PAL, 30 Hz or <9 Hz
Analog Video Connector Types	F-type BNC with BNC-to-RCA adapter included for video out	F-type BNC with BNC-to-RCA adapter included for video out
Network Video Output	Dual, Independent H.264 Network Video Streams	Dual, Independent H.264 Network Video Streams
HD-SDI Lossless Video Output	Yes	Yes
Power Requirements	24V DC	24V DC
Power Consumption	<50 W nominal; 130 W peak, 270 W 2/heaters	<50 W nominal; 130 W peak, 270 W 2/heaters
<b>ENVIRONMENTAL</b>		
Operating Temperature Range	-13°F to +131°F (-25°C to +55°C)	-13°F to +131°F (-25°C to +55°C)
Storage Temperature Range	-56° F to + 176°F (-50°C to +80°C)	-56° F to + 176°F (-50°C to +80°C)
Automatic Window Defrost	Standard at Power-Up	Standard at Power-Up
Sand/Dust Ingress	Mil-Std-810E	Mil-Std-810E
Water Ingress	IPX 6 (heavy seas, powerful jets of water)	IPX 6 (heavy seas, powerful jets of water)
Shock	15 g vertical, 9 g horizontal	15 g vertical, 9 g horizontal
Vibration	IEC 60945; MIL-STD-810E	IEC 60945; MIL-STD-810E
Lightning Protection	Standard	Standard
Salt Mist	IEC60945	IEC60945
Wind	100 knot (115.2 mph)	100 knot (115.2 mph)
EMI	IEC 60945	IEC 60945
<b>PHYSICAL</b>		
Weight	28 lbs (12.7 kg)	28 lbs (12.7 kg)
Size	10.75" (273.1 mm) x 15.65" (397.6 mm) – 18.05" (458.7mm) high with top down riser	
<b>RANGE PERFORMANCE</b>		
Person in the Water	1.3 nm (2.45 km)	1.3 nm (2.45 km)
Small Vessel	3.2 nm (6.0 km)	3.2 nm (6.0 km)

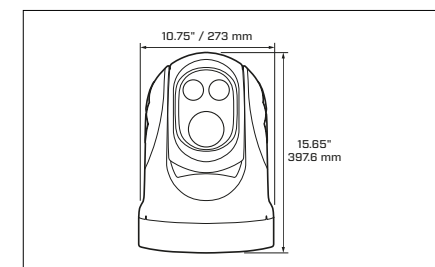

Specifications subject to change without prior notice. Images for reference purposes only.

**M500 SPECIFICATIONS**

	M500
	
<b>THERMAL CAMERA</b>	
Detector Type	Cooled MWIR InSb 640x512 Focal Plane Array
Video Refresh Rate	25 Hz (PAL) / 30 Hz (NTSC)
Field of View Limits	Optical 28° x 21° WFOV to 2° x 1.5° NFOV
Optical Zoom	1x to 14x (continuous)
E-Zoom	4x
NETD	<30 mK
Spectral Response	3-5 µm
<b>COLOR CAMERA</b>	
Visible Sensor	1/2.8" CMOS
Resolution	1920 x 1080
Field of View Limits	Optical 63.7° x 35.8° WFOV to 2.3° x 1.29° NFOV
E-Zoom	12x
<b>SYSTEM SPECIFICATIONS</b>	
Pan/Tilt Range	
Video Interface	Analog video, HD-SDI
Video over Ethernet	2 channels of streaming MPEG-4, H.264, or M-JPEG
NMEA0183	TCP/IP, RS-422, NMEA 0183, Pelco D
Communications	TCP/IP, RS-422, Pelco D
Video Formats	NTSC or PAL NTSC or PAL, 720p30, 1080p30
Power Requirements	12 VDC to 24 VDC (-10%+30% per IEC 60945)
Power Consumption	250 W (max w/heaters)
Output Modes	Black hot, white hot, false color palettes
Contrast Enhancement	AGC or manual, histogram equalization, local contrast enhancement algorithms available
Sharpness Enhancement	Automatic, adjustable Digital Detail Enhancement
Overlays	Integrated graphics overlays to indicate azimuth, AGC, active camera and menu control
<b>ENVIRONMENTAL</b>	
Operating temp	-25°C to +55°C
Storage temp	-50°C to +80°C
<b>PHYSICAL</b>	
Weight	45 lb (20.4 kg)
Size	10.75" (273 mm) dia. x 15.65" (397.5 mm) ht
<b>RANGE PERFORMANCE</b>	
Person in the Water	~4.9 nm (9.0 km)
Small Vessel	~8.3 nm (15.4 km)

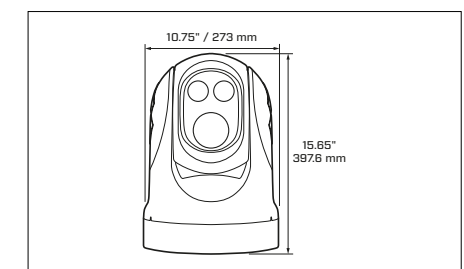

## US EXPORT REGULATIONS

Equipment described herein is subject to US export regulations and may require a license prior to export. Diversion contrary to US law is prohibited. Imagery for illustration purposes only. Specifications are subject to change without notice. ©2017 FLIR Systems, Inc. All rights reserved

## WARRANTY

FLIR's service commitment of outstanding warranty and technical support now offers you even more; by registering your system with FLIR at [www.flir.com/productreg](http://www.flir.com/productreg), the 2-Year Standard Limited Warranty is upgraded and replaced by the 3-Year Extended Limited Warranty for FREE.

For complete details on FLIR's industry-leading warranty please visit [www.flir.com/maritime](http://www.flir.com/maritime).

**FLIR MARITIME US INC.**  
9 TOWNSEND WEST  
NASHUA, NH 03063  
USA  
(603) 324-7900

**FLIR SYSTEMS INC.**  
27700 SW PARKWAY AVE  
WILSONVILLE, OR 97070  
USA  
(503)-498-3547

**FLIR BELGIUM BVBA**  
LUXEMBURGSTRAAT 2, 2321  
MEER  
BELGIUM  
+32 (0)3 287 87 10

EQUIPMENT DESCRIBED HEREIN MAY REQUIRE US GOVERNMENT AUTHORIZATION FOR EXPORT PURPOSES.  
DIVERSION CONTRARY TO US LAW IS PROHIBITED.  
SPECIFICATIONS ARE SUBJECT TO CHANGE WITHOUT NOTICE.

©2017 FLIR SYSTEMS, INC. ALL RIGHTS RESERVED. IMAGERY USED FOR ILLUSTRATION PURPOSES ONLY.



The World's **Sixth Sense**®

